

5 MLD WATER TREATMENT PLANT AT ERATTAYAR

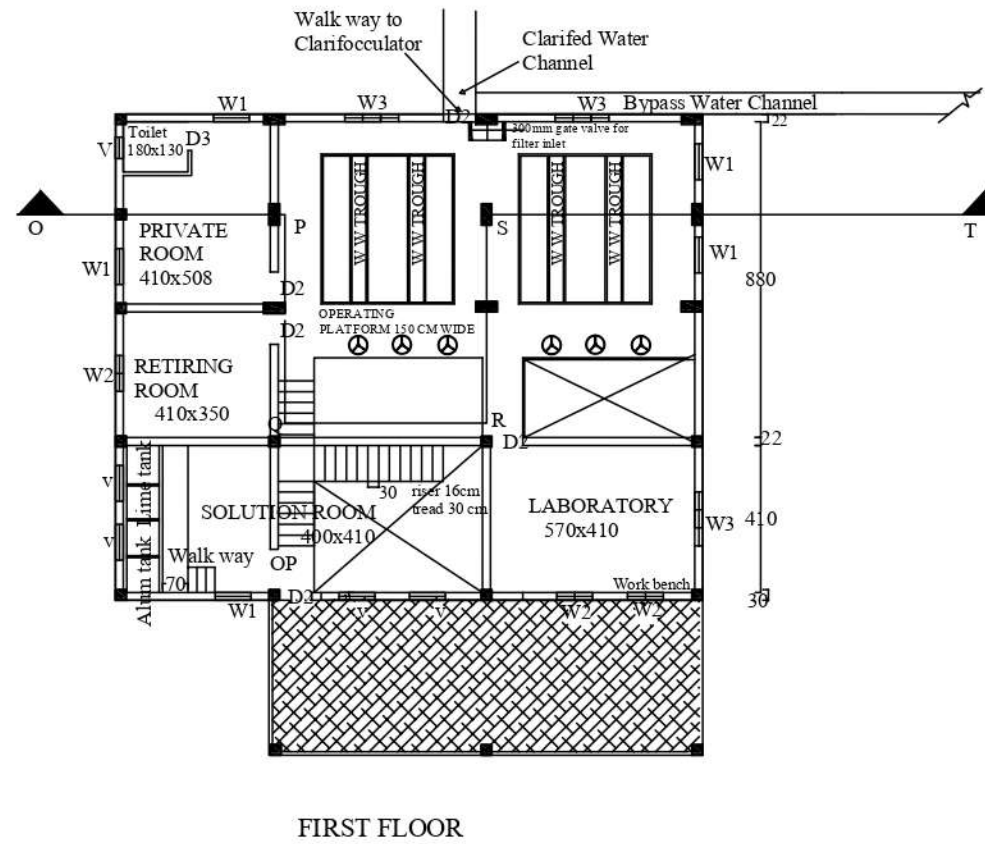
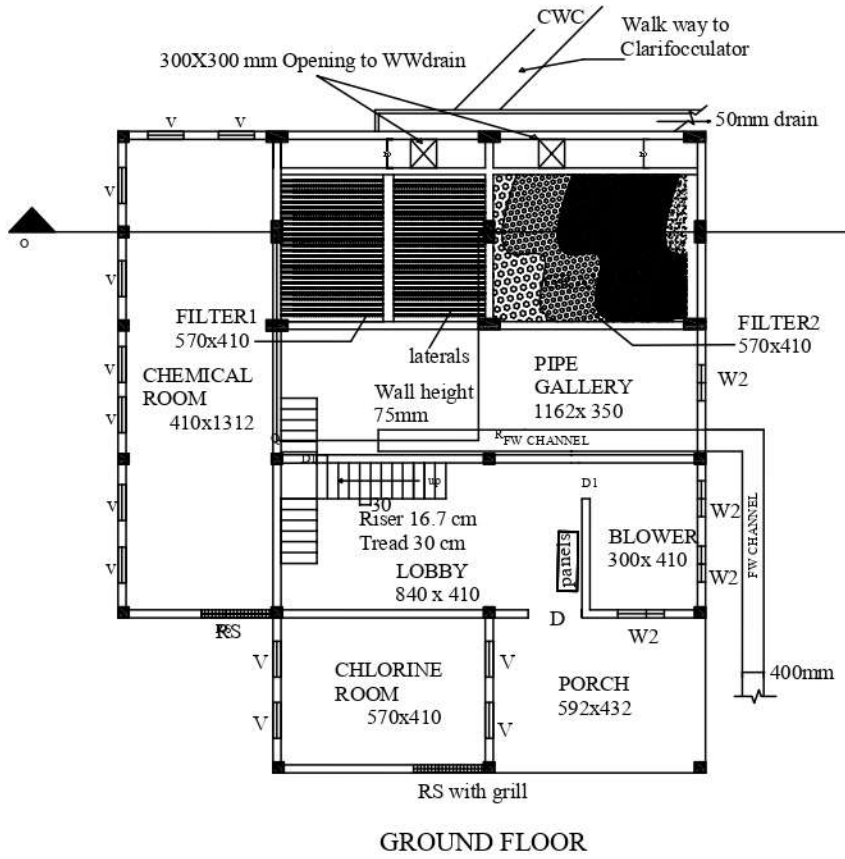
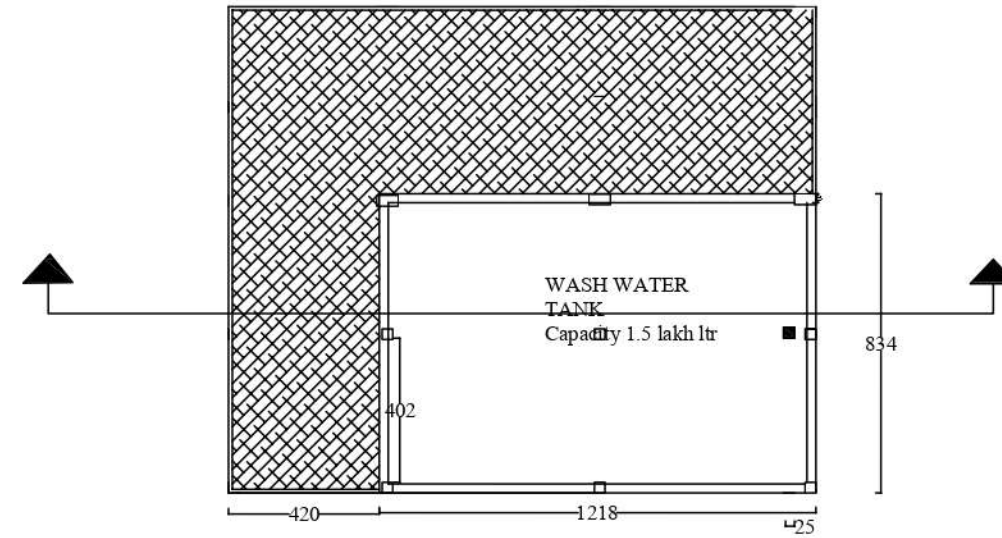
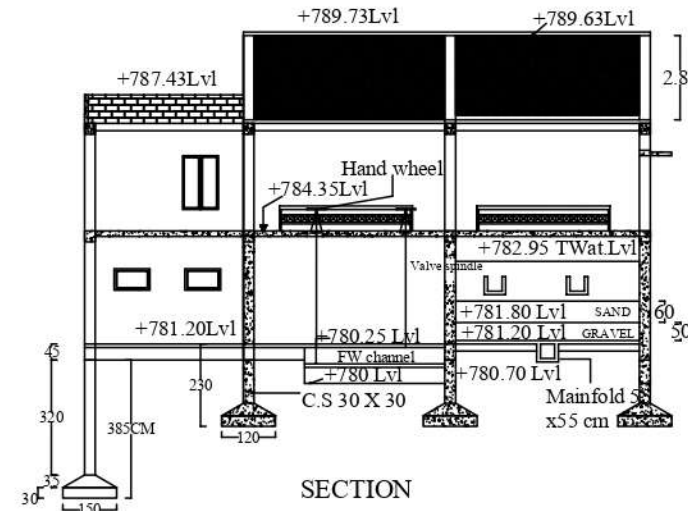
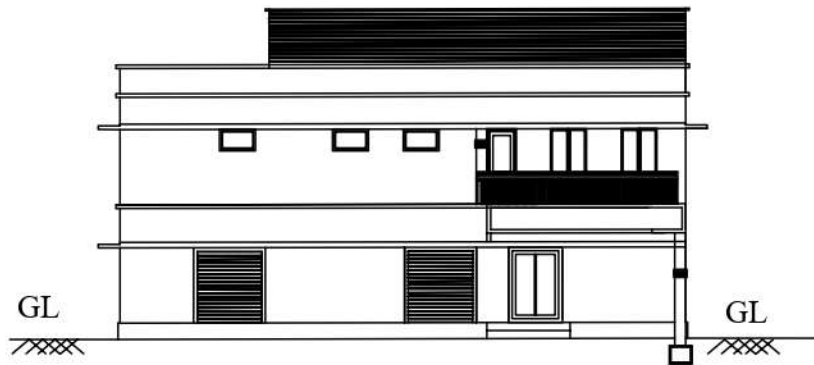

Notes
 All dimensions are in cm unless specified
 Levels indicated are in meters at top of slab
 Figured dimensions supersede measured one
 sunshade over openings are 60cm wide
 Alumn tank 0.9x1x1.2m
 Lime tank 0.8x0.8x1.2m

Specification for Filter media:
 Thickness of sand bed 600mm
 Effective size 0.45mm to 0.7mm
 Uniformity coefficient 1.3 to 1.7
 Thickness of gravel bed 500mm
 [2mm to 25mm size]
 U/D system : 75 mm PVC lateral @16cm c/c
 12mm holes @22cm c/c

V	Ventilator 100 X 60
W	Window 100 X 150
W1	Window 150 X 150
V1	Ventilator 150 X 60
D1	Door 150 X 210
D2	Door 100 X 210
D3	Door 90 X 210
D4	Door 80 X 210
OP	Opening 110 X 210
RS	Rolling Shutter 200 X 300
J	Jally 150 X 195

KERALA WATER AUTHORITY
PROJECT DIVISION, KATTAPPANA

 Assistant Engineer K.W.A. Project Division Kattappana	 Assistant Executive Engineer Kerala Water Authority Project Division Kattappana	 EXECUTIVE ENGINEER PROJECT DIVISION KERALA WATER AUTHORITY KATTAPPANA	AE	AEE	EE	SE	CHIEF ENGINEER	
JJM-PROVIDING FHTCS TO ALL HOUSEHOLDS IN ERATTAYAR AND KAMAKSHY (PART) PANCHAYATH.							DRG NO.	0/1
							SCALE	

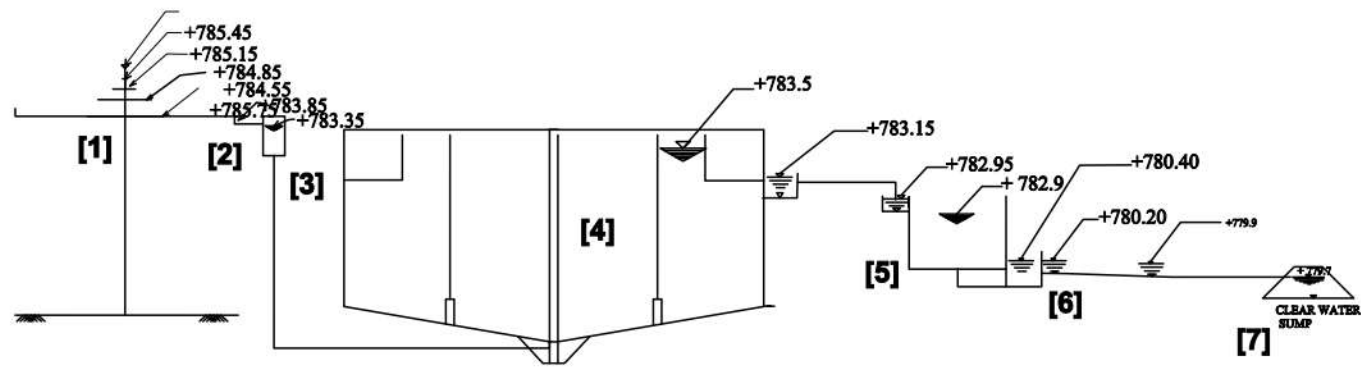

HYDRAULIC FLOW DIAGRAM

- 1 - AERATOR
- 2 - AERATOR CHANNEL
- 3 - FLASH MIXER
- 4 - CLARIFLOCCULATOR
- 5 - FILTER
- 6 - CLEAR WATER CHANNEL
- 7 - CLEAR WATER SUMP

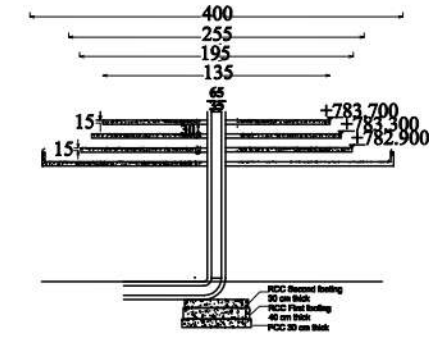

AERATOR SECTION

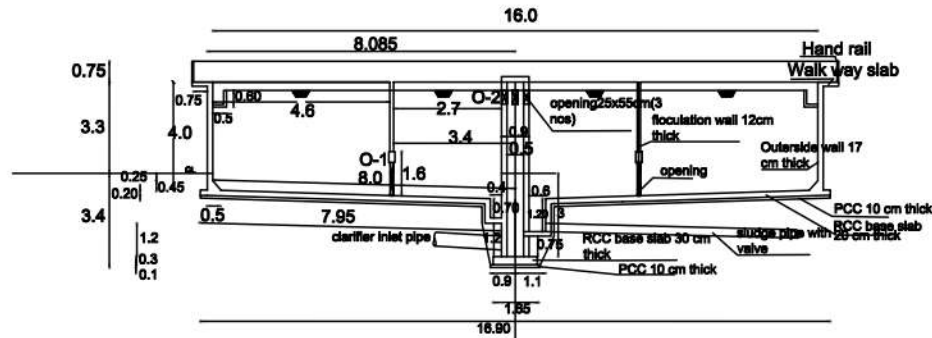

Clariflocculator

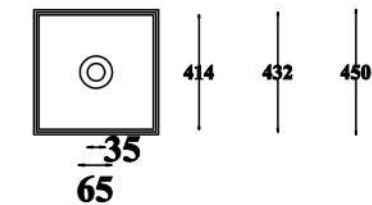
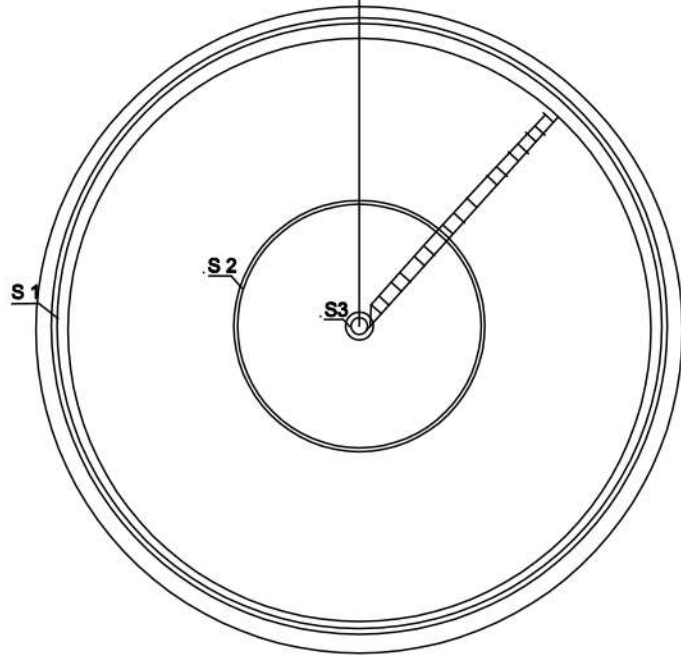

FOOTING S/C

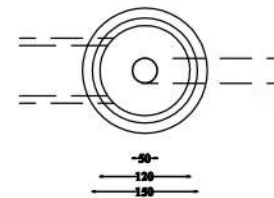
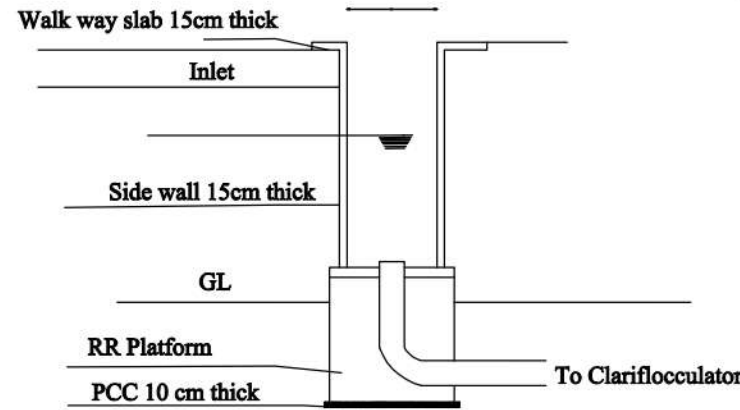

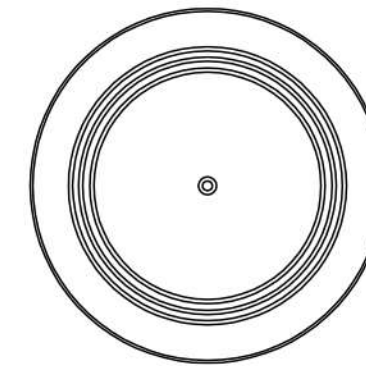

FLASH MIXER



AERATOR PLAN



 Assistant Executive Engineer
 Kerala Water Authority
 Project Division
 Kattappana

	KERALA WATER AUTHORITY	
	PROJECT DIVISION KATTAPPANA	
FILE NO :	SCALE:	
DRG NO : SCHEME 12/1	DATE : 21/09/2022	
PROJECT: JJM-PROVIDING FHTC'S TO ALLHOUSEHOLDS IN EARTTAYAR AND KAMAKSHI (PART) PANCHAYATHS IN IDUKKI DISTRICT		
	 ASST.ENGINEER : Assistant Engineer KWA Project Section Kattappana	

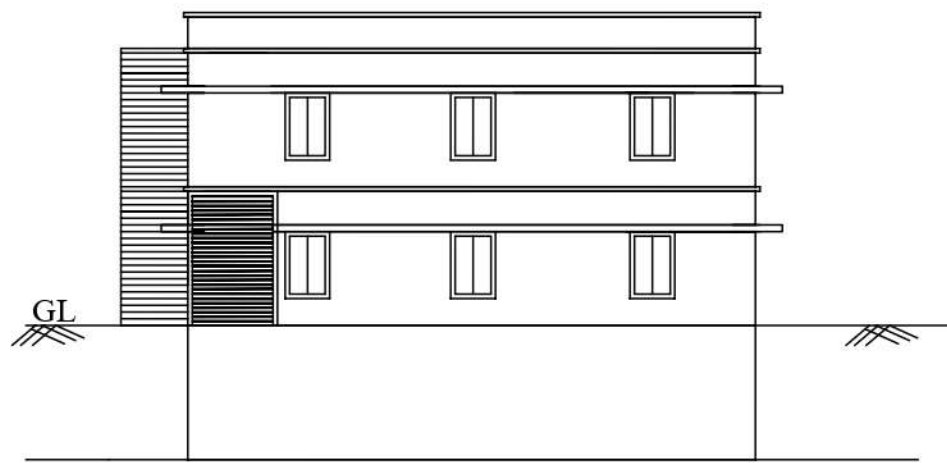
CLEAR WATER SUMP & PUMP HOUSE

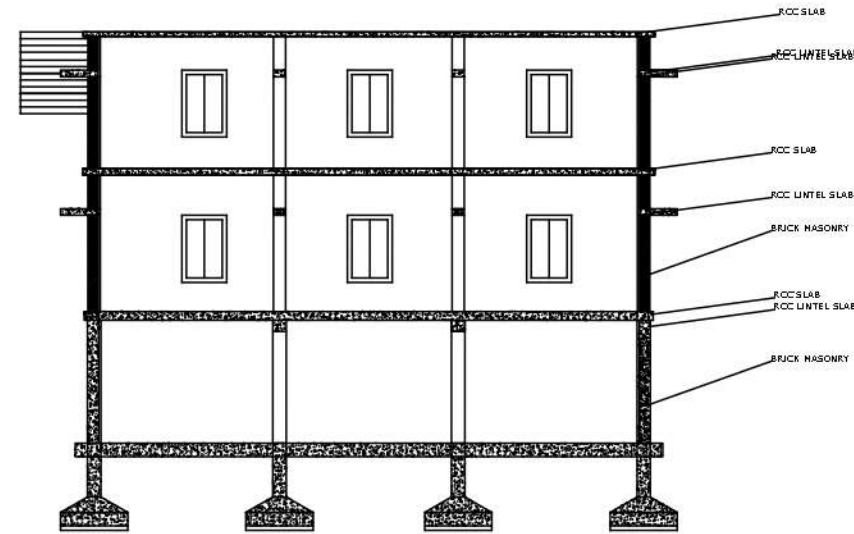
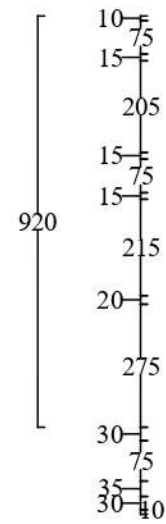

ELEVATION



SECTION

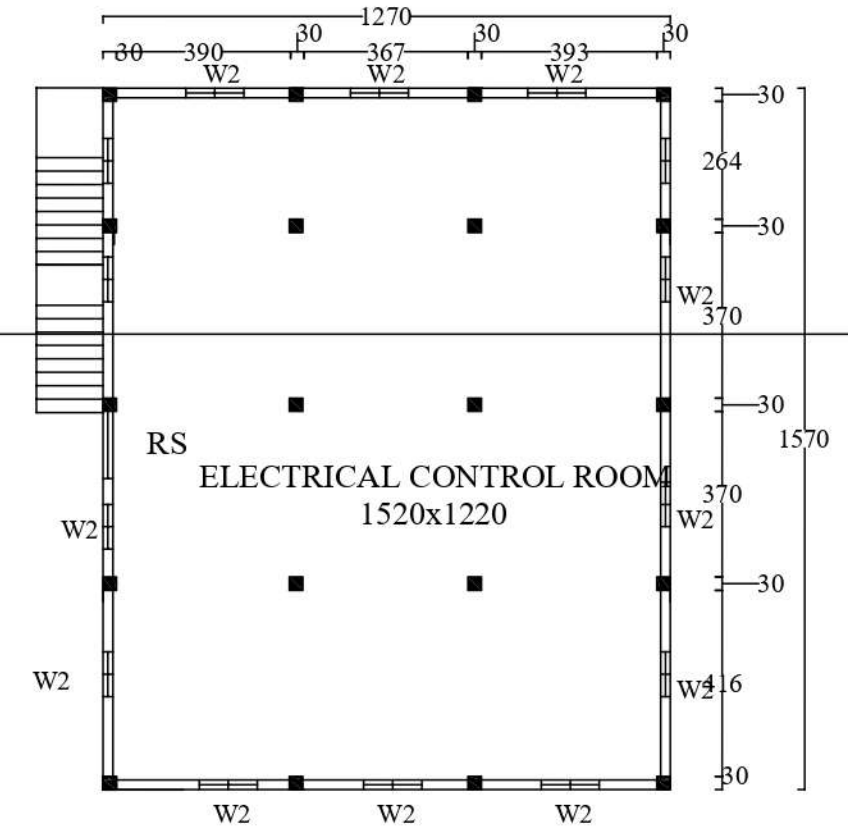

FIRST FLOOR

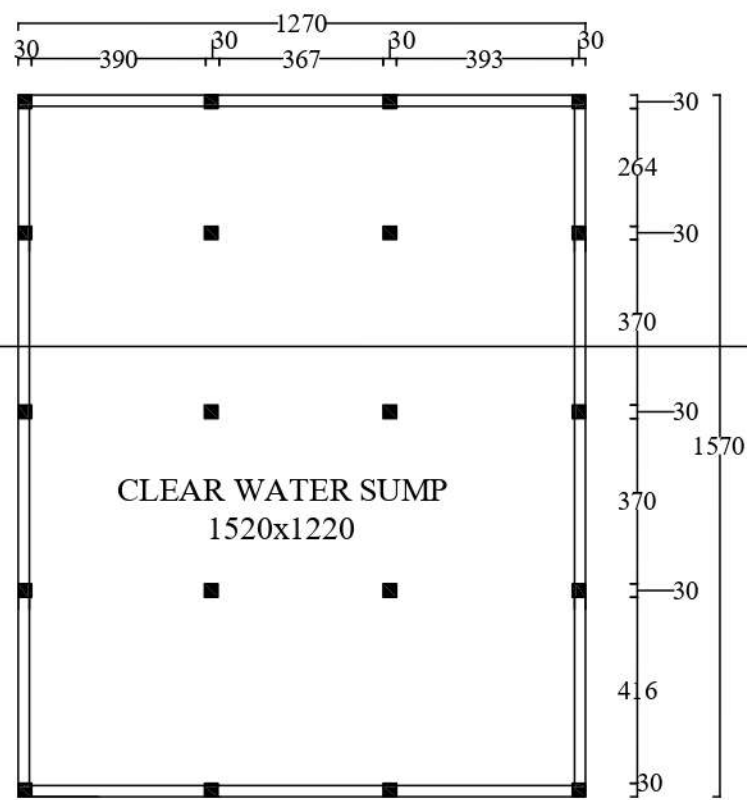

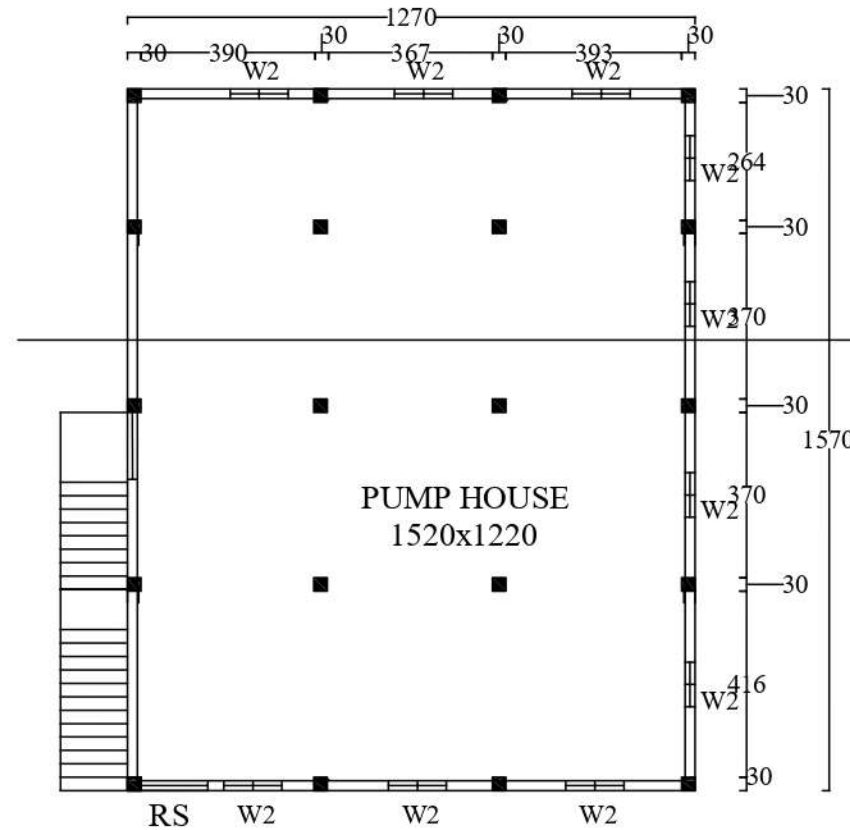

CLEAR WATER SUMP
1520x1220



PUMP HOUSE
1520x1220

GROUND FLOOR

KERALA WATER AUTHORITY PROJECT DIVISION, KATTAPPANA

 Assistant Engineer KWA Project Section Kattappana	 Assistant Executive Engineer Kerala Water Authority Project Division Kattappana	 EXECUTIVE ENGINEER PROJECT DIVISION KERALA WATER AUTHORITY KATTAPPANA		
AE	AEE	EE	SE	CHIEF ENGINEER

JJM-PROVIDING FHTCS TO ALL HOUSEHOLDS
IN ERATTAYAR AND KAMAKSHY (PART)
PANCHAYATH.

DRG NO. 0/1
SCALE